

# ZERTIFIKAT

Zertifizierte Passivhaus-Komponente

Komponenten-ID 0905ws03 gültig bis 31. Dezember 2023

Passivhaus Institut  
Dr. Wolfgang Feist  
64283 Darmstadt  
Deutschland

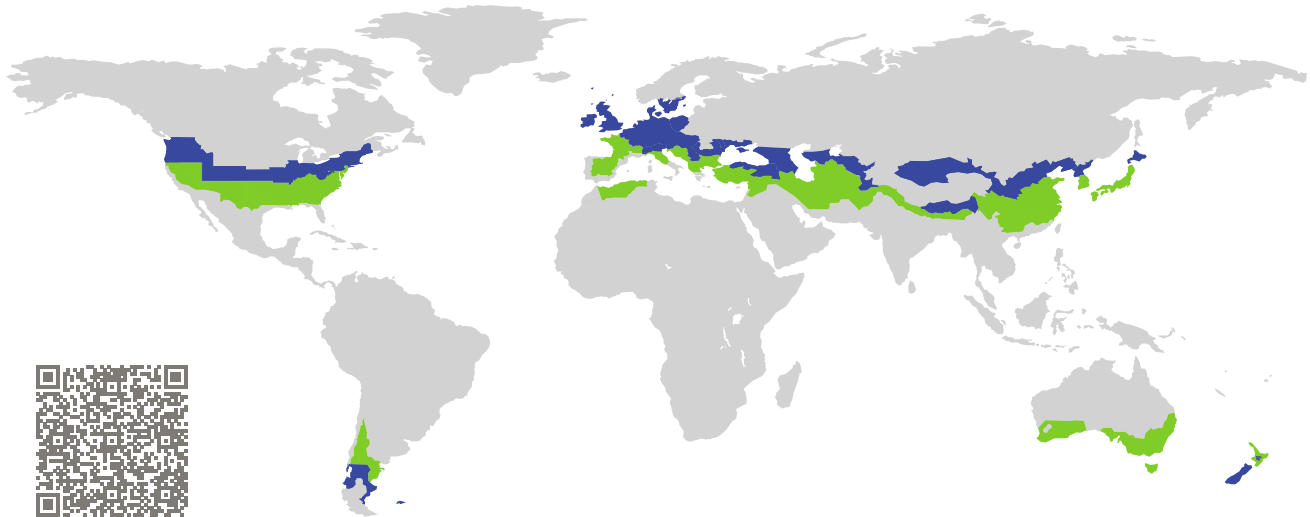

Kategorie: **Fenster System**  
Hersteller: **pro Passivhausfenster GmbH,  
Oberaudorf,  
Deutschland**  
Produktname: **smartwin**

**Folgende Kriterien für die kühl-gemäßigte Klimazone  
wurden geprüft**

Behaglichkeit  $U_W = 0,77 \leq 0,80 \text{ W}/(\text{m}^2 \text{ K})$   
 $U_{W,\text{eingebaut}} \leq 0,85 \text{ W}/(\text{m}^2 \text{ K})$   
mit  $U_g = 0,70 \text{ W}/(\text{m}^2 \text{ K})$

Hygiene  $f_{Rsi=0,25} \geq 0,70$   
Luftdichtheit  $Q_{100} = 0,11 \leq 0,25 \text{ m}^3/(\text{h m})$



kühl-gemäßigtes Klima



**ZERTIFIZIERTE  
KOMPONENTE**

Passivhaus Institut

Passivhaus-  
Effizienzklasse

phE

phD

phC

phB

phA

[www.passiv.de](http://www.passiv.de)

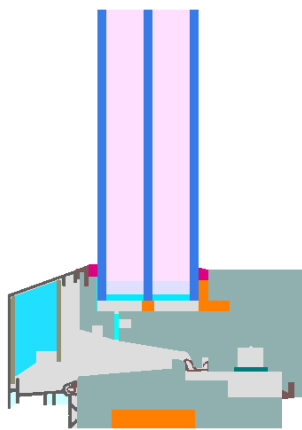

Berechnungsmodell

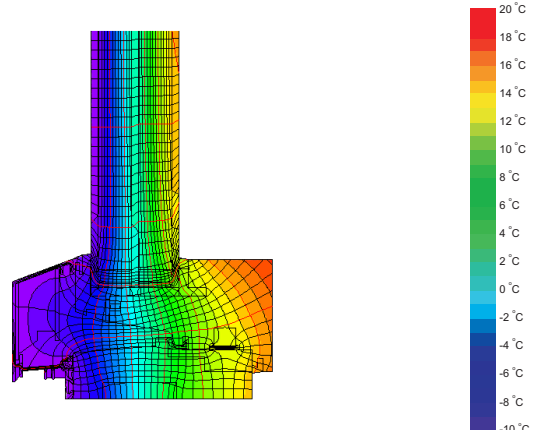

Isothermengrafik

## Beschreibung

Holz-Aluminium Rahmen aus Tanne/Fichte (0,11 W/(mK)), isoliert mit Holzweichfaserplatten (0,05 u. 0,04 W/(mK)) und PU Dämmung (0,03 W/(mK)). Glasaufbau: 4/18/4/18/4, Glaseinstand 15 mm. Q100 = 0,11 m<sup>2</sup>/mh gemessen an einer Stulpfenstertüre (200 \* 260 cm). Glasstärke: 48 mm (4/18/4/18/4), Glaseinstand: 15 mm, Abstandhalter: SWISSPACER Ultimate mit PU Sekundärdichtung.

## Erläuterung





Die Fenster-U-Werte wurden für die Prüfenstergröße von 2,46 m × 1,48 m bei  $U_g = 0,70 \text{ W}/(\text{m}^2 \text{ K})$  berechnet. Werden höherwertige Verglasungen eingesetzt, verbessern sich die Fenster-U-Werte wie folgt:

Verglasung	$U_g =$	0,70	0,64	0,58	0,52	W/(m <sup>2</sup> K)
		↓	↓	↓	↓	
Fenster	$U_W =$	0,77	0,72	0,67	0,62	W/(m <sup>2</sup> K)

Transparente Bauteile werden abhängig von den Wärmeverlusten durch den opaken Teil in Effizienzklassen eingestuft. In diese Wärmeverluste gehen die Rahmen-U-Werte, die Rahmenbreiten, Glasrand und die Glasrandlängen ein. Ein ausführlicher Bericht über die im Rahmen der Zertifizierung durchgeführten Berechnungen ist beim Hersteller erhältlich.



Das Passivhaus Institut hat weltweite Komponentenanforderungen für sieben Klimazonen definiert. Grundsätzlich können Komponenten, die für Klimazonen mit höheren Anforderungen zertifiziert sind, auch in Klimazonen mit geringeren Anforderung eingesetzt werden. Es kann wirtschaftlich sinnvoll sein, in einer Klimazone eine thermisch höherwertige Komponente, die für eine Klimazone mit strengeren Anforderungen zertifiziert wurde, einzusetzen.

Weitere Informationen zur Zertifizierung sind unter [www.passiv.de](http://www.passiv.de) und [www.passipedia.de](http://www.passipedia.de) verfügbar.

Rahmen-Kennwerte		Rahmenbreite $b_f$ mm	Rahmen- $U$ -Wert $U_f$ W/(m <sup>2</sup> K)	Glasrand- $\Psi$ -Wert $\Psi_g$ W/(m K)	Temperaturfaktor $f_{RSi=0,25}$ [-]
Pfosten fest	(0M1) 	110	0,62	0,021	0,74
Pfosten fest	(0M2) 	110	0,78	0,020	0,72
Riegel fest	(0T1) 	110	0,79	0,020	0,71
Riegel fest	(0T2) 	110	0,79	0,020	0,72
Pfosten 1 Flügel	(1M1) 	110	0,73	0,021	0,73
Pfosten 1 Flügel	(1M2) 	110	0,92	0,020	0,71
Riegel 1 Flügel	(1T1) 	110	0,90	0,020	0,71
Riegel 1 Flügel	(1T2) 	110	0,90	0,020	0,71
Pfosten 2 Flügel	(2M1) 	142	0,71	0,021	0,74
Pfosten 2 Flügel	(2M2) 	142	0,92	0,020	0,72
Riegel 2 Flügel	(2T1) 	142	0,92	0,020	0,71
Riegel 2 Flügel	(2T2) 	142	0,95	0,020	0,70
Tür Seite	(DS1) 	142	0,72	0,020	0,73
Unten fest	(FB1) 	76	0,72	0,020	0,74
Oben fest	(FH1) 	67	0,53	0,021	0,76
Seitlich fest	(FJ1) 	67	0,53	0,021	0,76
Stulp	(FM1) 	110	0,73	0,020	0,74
Stulp	(FM2) 	110	0,90	0,020	0,72
Unten	(OB1) 	76	0,93	0,020	0,72

Abstandhalter: SWISSPACER Ultimate

Sekundärdichtung: Polyurethan

Rahmen-Kennwerte		Rahmenbreite $b_f$ mm	Rahmen- $U$ -Wert $U_f$ W/(m <sup>2</sup> K)	Glasrand- $\Psi$ -Wert $\Psi_g$ W/(m K)	Temperaturfaktor $f_{Rsi=0,25}$ [-]
Oben	(OH1) 	67	0,71	0,021	0,75
Seitlich	(OJ1) 	67	0,71	0,021	0,75
Schwelle	(OT2) 	76	0,97	0,020	0,72

Abstandhalter: SWISSPACER Ultimate      Sekundärdichtung: Polyurethan



**Pfosten**  
fest

$b_f = 110$  mm  
 $U_f = 0,62$  W/(m<sup>2</sup> K)  
 $\Psi_g = 0,021$  W/(m K)  
 $f_{Rsi} = 0,74$

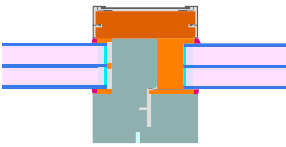
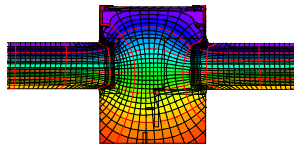



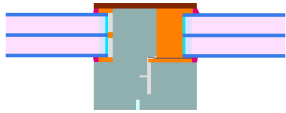
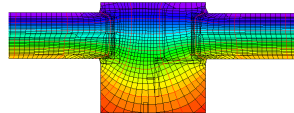

**Pfosten**  
fest

$b_f = 110$  mm  
 $U_f = 0,78$  W/(m<sup>2</sup> K)  
 $\Psi_g = 0,020$  W/(m K)  
 $f_{Rsi} = 0,72$





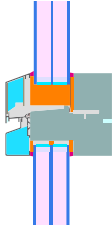
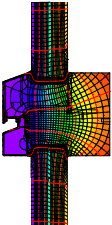

**Riegel**  
fest

$b_f = 110$  mm  
 $U_f = 0,79$  W/(m<sup>2</sup> K)  
 $\Psi_g = 0,020$  W/(m K)  
 $f_{Rsi} = 0,71$



**Riegel**  
fest

$b_f = 110$  mm  
 $U_f = 0,79$  W/(m<sup>2</sup> K)  
 $\Psi_g = 0,020$  W/(m K)  
 $f_{Rsi} = 0,72$

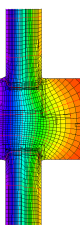

**Pfosten**  
1 Flügel

$$b_f = 110 \text{ mm}$$
$$U_f = 0,73 \text{ W}/(\text{m}^2 \text{ K})$$
$$\Psi_g = 0,021 \text{ W}/(\text{m K})$$
$$f_{Rsi} = 0,73$$

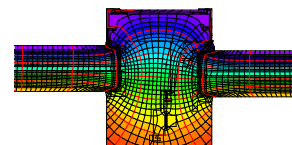
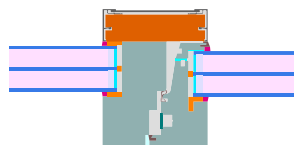

**Pfosten**  
1 Flügel

$$b_f = 110 \text{ mm}$$
$$U_f = 0,92 \text{ W}/(\text{m}^2 \text{ K})$$
$$\Psi_g = 0,020 \text{ W}/(\text{m K})$$
$$f_{Rsi} = 0,71$$

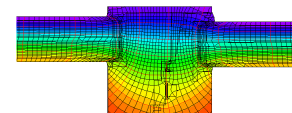
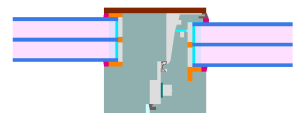

**Riegel**  
1 Flügel

$$b_f = 110 \text{ mm}$$
$$U_f = 0,90 \text{ W}/(\text{m}^2 \text{ K})$$
$$\Psi_g = 0,020 \text{ W}/(\text{m K})$$
$$f_{Rsi} = 0,71$$

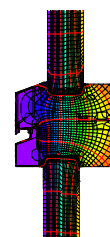
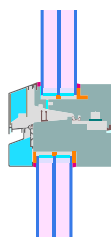

**Riegel**  
1 Flügel

$$b_f = 110 \text{ mm}$$
$$U_f = 0,90 \text{ W}/(\text{m}^2 \text{ K})$$
$$\Psi_g = 0,020 \text{ W}/(\text{m K})$$
$$f_{Rsi} = 0,71$$

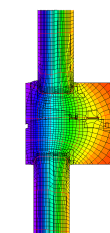
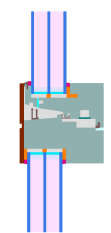

**Pfosten**  
2 Flügel

$$b_f = 142 \text{ mm}$$
$$U_f = 0,71 \text{ W}/(\text{m}^2 \text{ K})$$
$$\Psi_g = 0,021 \text{ W}/(\text{m K})$$
$$f_{Rsi} = 0,74$$

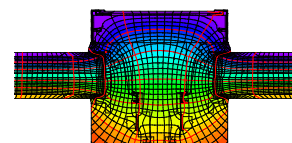
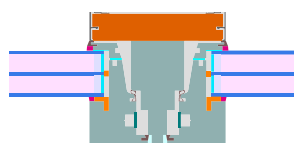



### Pfosten 2 Flügel

$$b_f = 142 \text{ mm}$$
$$U_f = 0,92 \text{ W}/(\text{m}^2 \text{ K})$$
$$\Psi_g = 0,020 \text{ W}/(\text{m K})$$
$$f_{Rsi} = 0,72$$

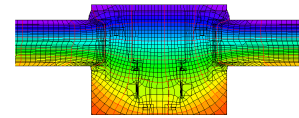
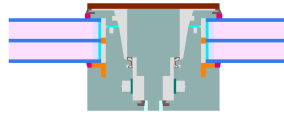

### Riegel 2 Flügel

$$b_f = 142 \text{ mm}$$
$$U_f = 0,92 \text{ W}/(\text{m}^2 \text{ K})$$
$$\Psi_g = 0,020 \text{ W}/(\text{m K})$$
$$f_{Rsi} = 0,71$$

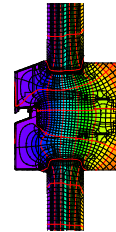

### Riegel 2 Flügel

$$b_f = 142 \text{ mm}$$
$$U_f = 0,95 \text{ W}/(\text{m}^2 \text{ K})$$
$$\Psi_g = 0,020 \text{ W}/(\text{m K})$$
$$f_{Rsi} = 0,70$$

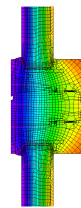

### Tür Seite

$$b_f = 142 \text{ mm}$$
$$U_f = 0,72 \text{ W}/(\text{m}^2 \text{ K})$$
$$\Psi_g = 0,020 \text{ W}/(\text{m K})$$
$$f_{Rsi} = 0,73$$

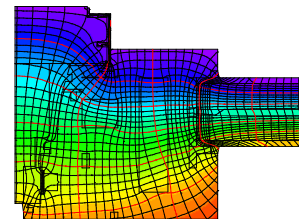
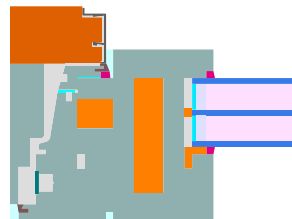

### Unten fest

$$b_f = 76 \text{ mm}$$
$$U_f = 0,72 \text{ W}/(\text{m}^2 \text{ K})$$
$$\Psi_g = 0,020 \text{ W}/(\text{m K})$$
$$f_{Rsi} = 0,74$$

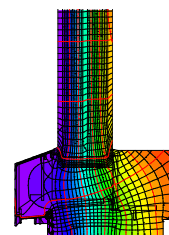
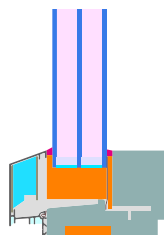



Oben  
fest

$$b_f = 67 \text{ mm}$$

$$U_f = 0,53 \text{ W/(m}^2 \text{ K)}$$

$$\Psi_g = 0,021 \text{ W/(m K)}$$

$$f_{Rsi} = 0,76$$

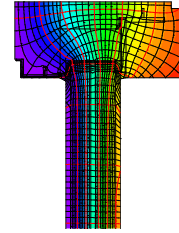
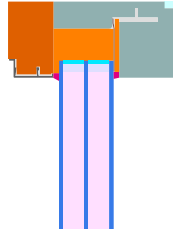

Seitlich  
fest

$$b_f = 67 \text{ mm}$$

$$U_f = 0,53 \text{ W/(m}^2 \text{ K)}$$

$$\Psi_g = 0,021 \text{ W/(m K)}$$

$$f_{Rsi} = 0,76$$

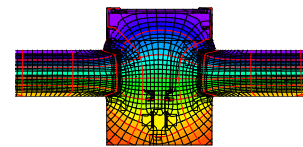
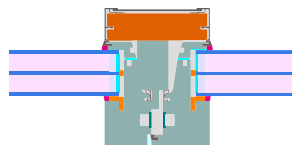

Stulp

$$b_f = 110 \text{ mm}$$

$$U_f = 0,73 \text{ W/(m}^2 \text{ K)}$$

$$\Psi_g = 0,020 \text{ W/(m K)}$$

$$f_{Rsi} = 0,74$$

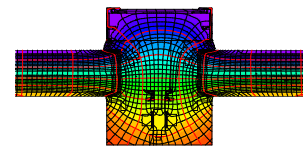
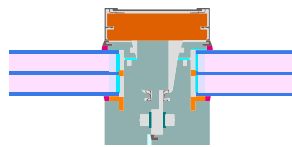

Stulp

$$b_f = 110 \text{ mm}$$

$$U_f = 0,90 \text{ W/(m}^2 \text{ K)}$$

$$\Psi_g = 0,020 \text{ W/(m K)}$$

$$f_{Rsi} = 0,72$$

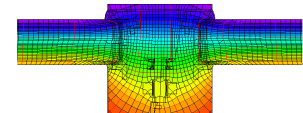
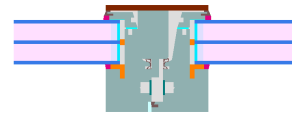

Unten

$$b_f = 76 \text{ mm}$$

$$U_f = 0,93 \text{ W/(m}^2 \text{ K)}$$

$$\Psi_g = 0,020 \text{ W/(m K)}$$

$$f_{Rsi} = 0,72$$

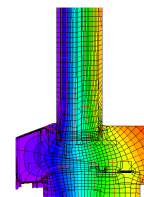
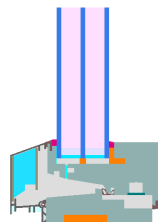



### Oben

$$b_f = 67 \text{ mm}$$
$$U_f = 0,71 \text{ W/(m}^2 \text{ K)}$$
$$\Psi_g = 0,021 \text{ W/(m K)}$$
$$f_{Rsi} = 0,75$$

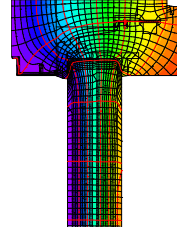
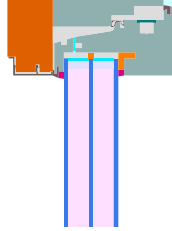

### Seitlich

$$b_f = 67 \text{ mm}$$
$$U_f = 0,71 \text{ W/(m}^2 \text{ K)}$$
$$\Psi_g = 0,021 \text{ W/(m K)}$$
$$f_{Rsi} = 0,75$$



### Schwelle

$$b_f = 76 \text{ mm}$$
$$U_f = 0,97 \text{ W/(m}^2 \text{ K)}$$
$$\Psi_g = 0,020 \text{ W/(m K)}$$
$$f_{Rsi} = 0,72$$

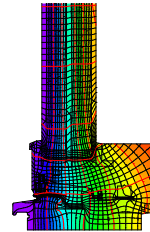
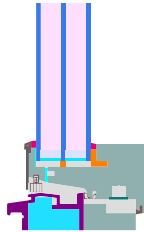



# Geprüfte Einbausituationen

**Betonschalungsstein (fest verglast)**

$U_{Wand} = 0,15 \text{ W}/(\text{m}^2 \text{ K})$

$\Psi_{\text{einbau}}$	W/(m K)
Oben	0,005
Links	0,005
Rechts	0,005
Unten	0,022

$U_{W,\text{eingebaut}} = 0,79 \text{ W}/(\text{m}^2 \text{ K})$

**Betonschalungsstein (öffnbar)**

$U_{Wand} = 0,15 \text{ W}/(\text{m}^2 \text{ K})$

$\Psi_{\text{einbau}}$	W/(m K)
Oben	0,006
Links	0,006
Rechts	0,006
Unten	0,024

$U_{W,\text{eingebaut}} = 0,79 \text{ W}/(\text{m}^2 \text{ K})$

**Holzleichtbau (fest verglast)**

$U_{Wand} = 0,13 \text{ W}/(\text{m}^2 \text{ K})$

$\Psi_{\text{einbau}}$	W/(m K)
Oben	0,015
Links	0,015
Rechts	0,015
Unten	0,024

$U_{W,\text{eingebaut}} = 0,81 \text{ W}/(\text{m}^2 \text{ K})$

**Holzleichtbau (öffnbar)**

$U_{Wand} = 0,13 \text{ W}/(\text{m}^2 \text{ K})$

$\Psi_{\text{einbau}}$	W/(m K)
Oben	0,015
Links	0,015
Rechts	0,015
Unten	0,023

$U_{W,\text{eingebaut}} = 0,81 \text{ W}/(\text{m}^2 \text{ K})$

**Schwelle Balkontür**

$U_{Wand} = 0,13 \text{ W}/(\text{m}^2 \text{ K})$

$\Psi_{\text{einbau}}$	W/(m K)
Oben	
Links	
Rechts	
Unten	0,014

$U_{W,\text{eingebaut}} = \text{W}/(\text{m}^2 \text{ K})$

**Wärmedämmverbundsystem (WDVS) (fest verglast)**

$U_{Wand} = 0,13 \text{ W}/(\text{m}^2 \text{ K})$

$\Psi_{\text{einbau}}$	W/(m K)
Oben	0,003
Links	0,003
Rechts	0,003
Unten	0,021

$U_{W,\text{eingebaut}} = 0,79 \text{ W}/(\text{m}^2 \text{ K})$

